

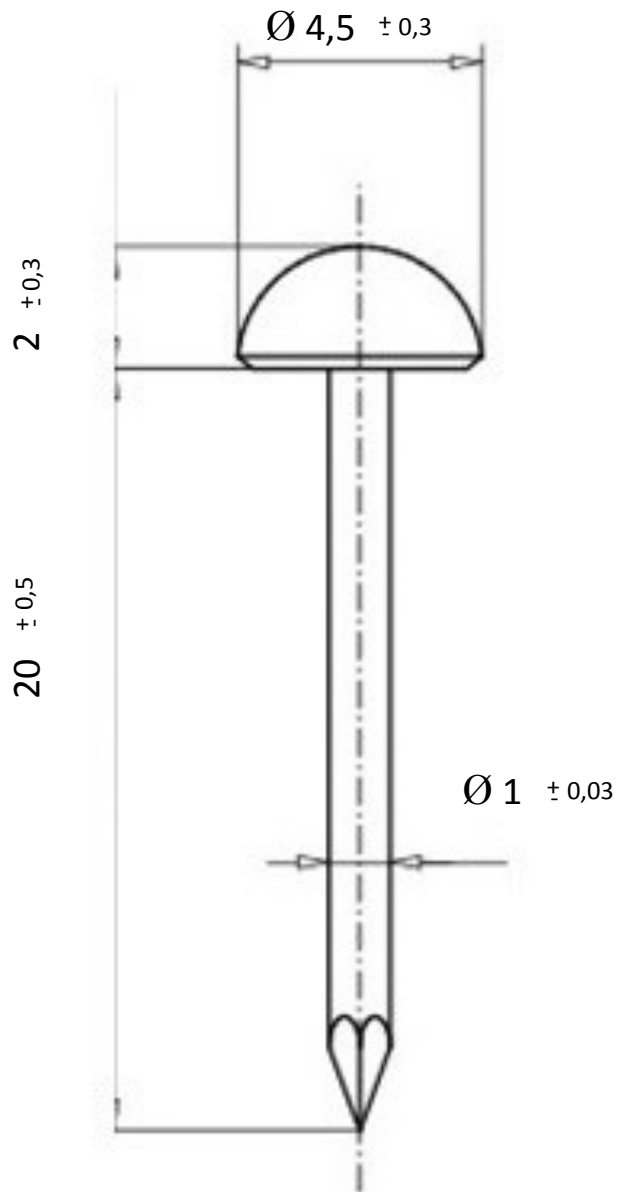

PERLE Ø 4,5 mm

FER



REPRODUCTION INTERDITE SANS NOTRE ACCORD

Composition	C	Si	Mn	P	S	Al
	0,066	0,011	0,339	0,01	0,011	0,045
Conditionnement	Boite		Carton		Palette	
	1 000		50 000			
Poids	0,22 Kg / 1000		Résistance en traction	356 N/mm ²		
Observations :						
Suivant Norme ISO 2768m					01/09/2019	