

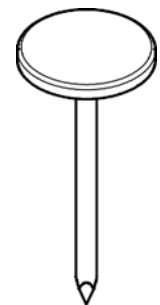

CLOU CALOTIN Ø 16

ACIER

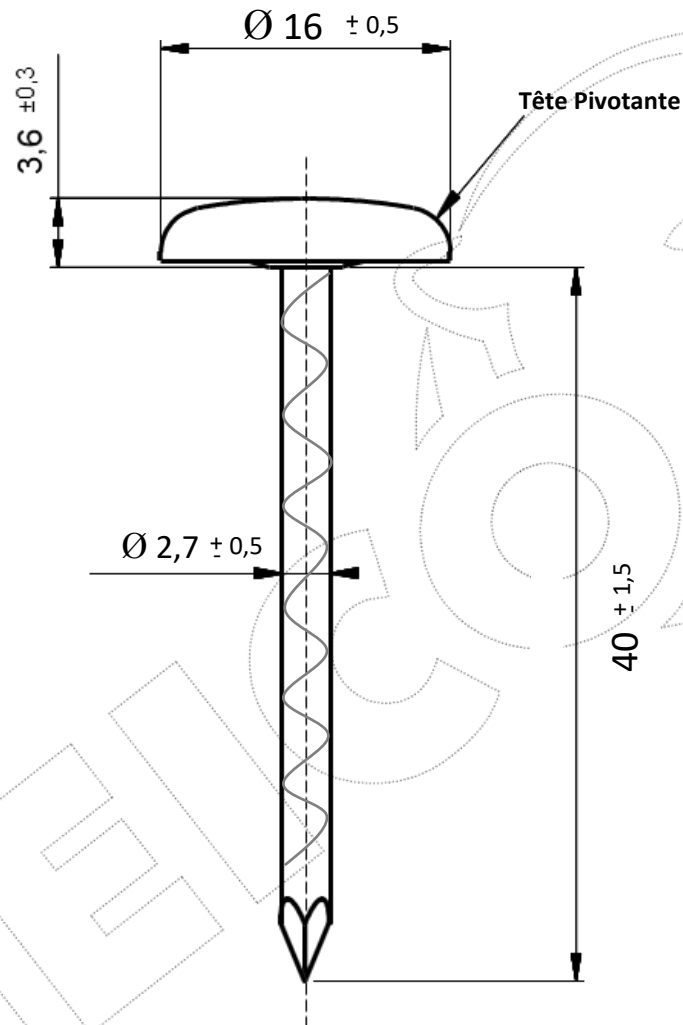

REPRODUCTION INTERDITE SANS NOTRE ACCORD

SAE1006	Test Corrosion	120h Zn / 720h Fe
---------	----------------	-------------------

Conditionnement	Boite	Carton	Palette
	250	3 000	

Poids	Résistance à la traction	2600 N
-------	--------------------------	--------

Observations : Pointe Torsadée

Minimum de Production

Suivant Norme ISO 2768m

01/09/2019