

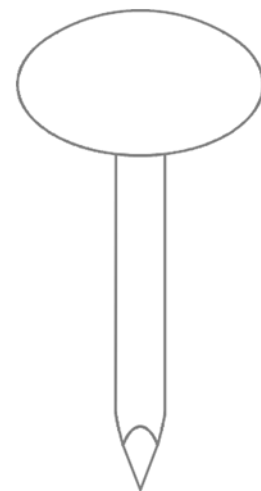

LENTILLE Ø 9,5 mm

FER

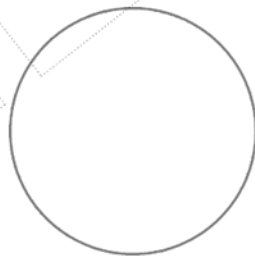
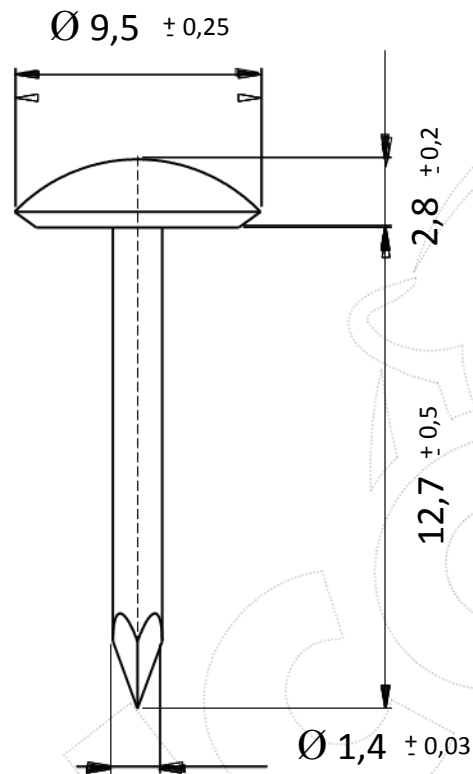

REPRODUCTION INTERDITE SANS NOTRE ACCORD

Composition	C	Si	Mn	P	S	Al
	0,066	0,011	0,339	0,01	0,011	0,045

Conditionnement	Boite	Carton	Palette
	1000		

Poids	0,62 Kg / 1000	Résistance en traction	356 N/mm <sup>2</sup>
-------	----------------	------------------------	-----------------------

Observations :

Suivant Norme ISO 2768m

01/09/2019