

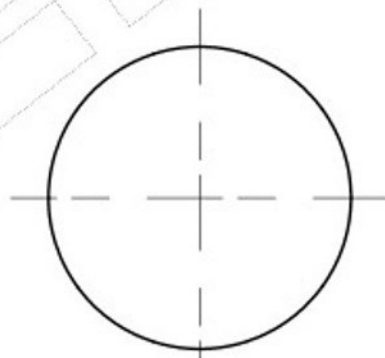

LENTILLE Ø 8 mm

FER

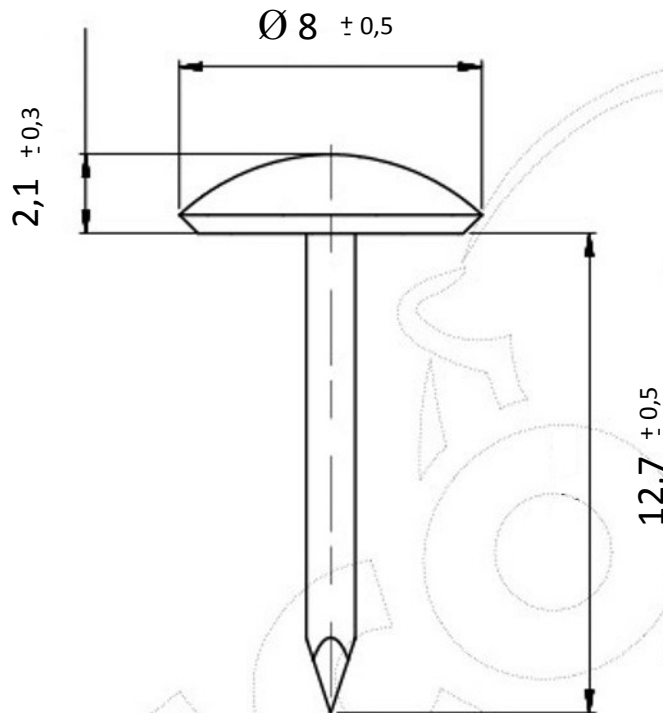

REPRODUCTION INTERDITE SANS NOTRE ACCORD

Composition	C	Si	Mn	P	S	Al
	0,066	0,011	0,339	0,01	0,011	0,045

Conditionnement	Boite	Carton	Palette
	1 000	40 000	

Poids	0,42 Kg / 1000	Résistance en traction	356 N/mm ²
-------	----------------	------------------------	-----------------------

Observations :

Suivant Norme ISO 2768m

01/09/2019