

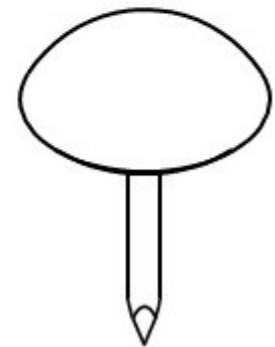

PERLE Ø 9 mm

LAITON

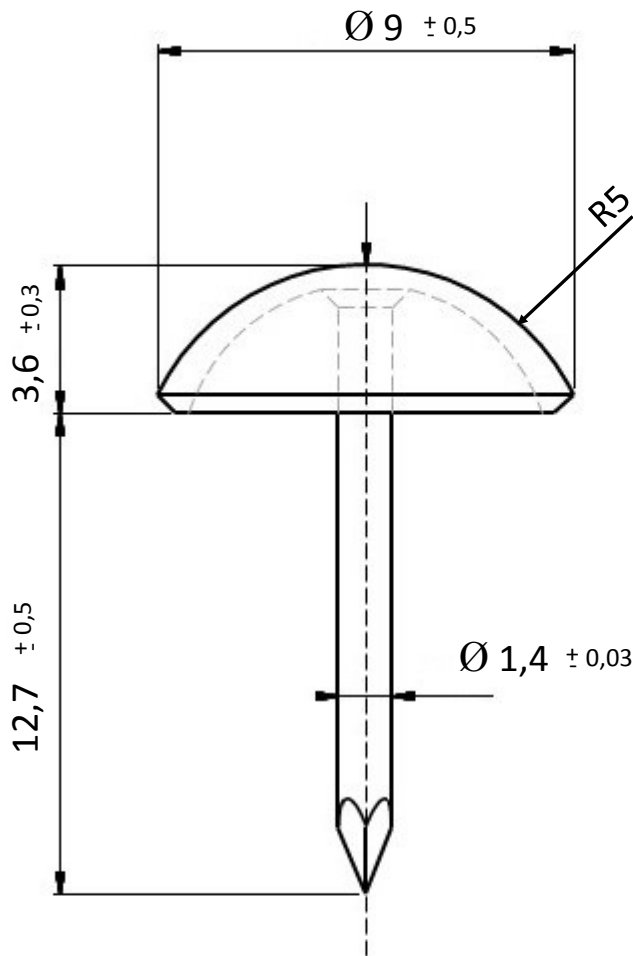

REPRODUCTION INTERDITE SANS NOTRE ACCORD

Composition	Cu	Zn	Sn	Pb	Ni	
	63,29	Reste	-	0,006	0,009	
Conditionnement	Boite		Carton		Palette	
	1 000		20 000			
Poids	0,67 Kg / 1000		Résistance en traction	450 N/mm ²		
Observations :						
Suivant Norme ISO 2768m					01/09/2019	