

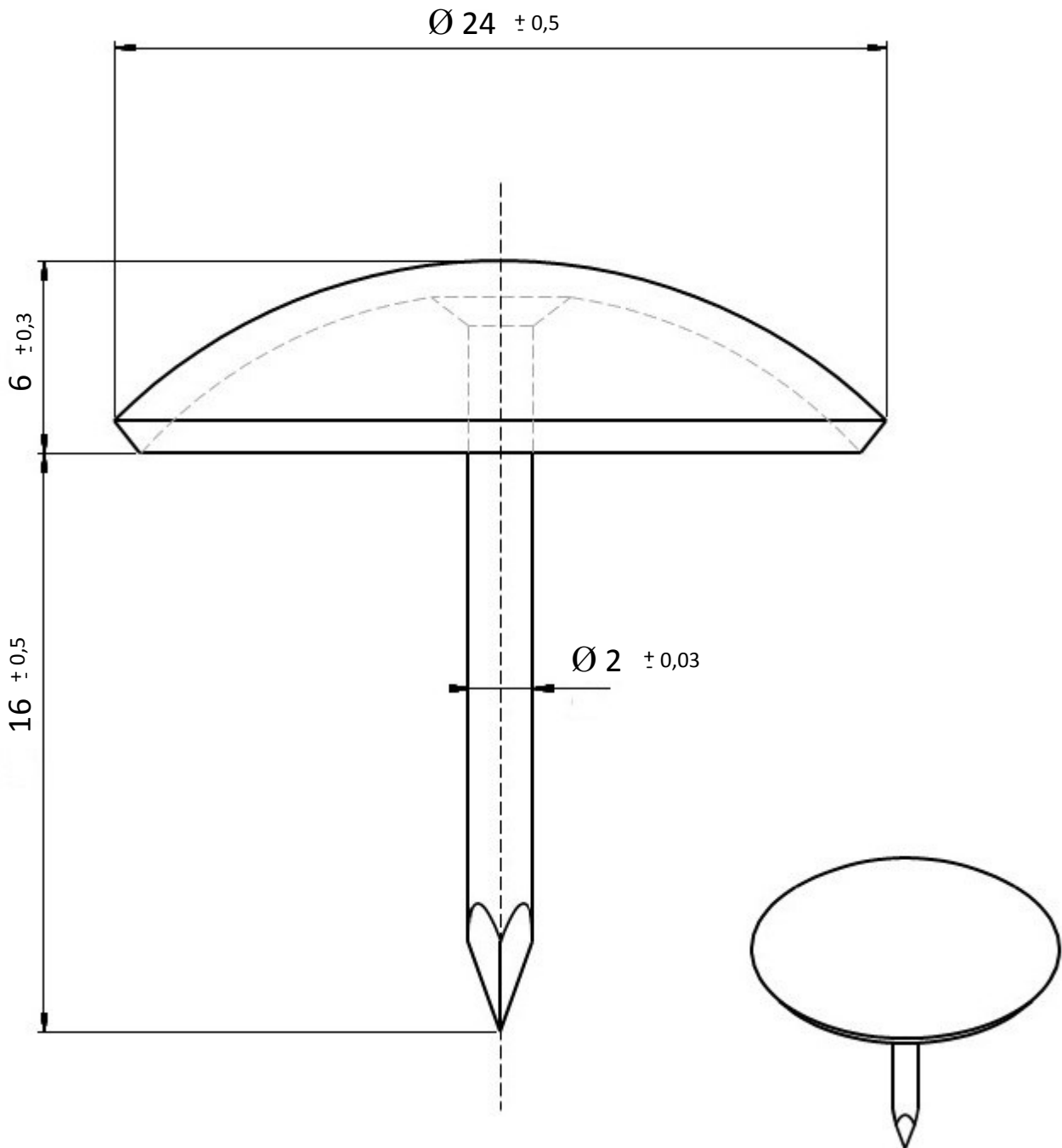

LENTILLE Ø 24 mm

FER



REPRODUCTION INTERDITE SANS NOTRE ACCORD

Composition	C	Si	Mn	P	S	Al
	0,066	0,011	0,339	0,01	0,011	0,045
Conditionnement	Boite		Carton		Palette	
	250		2 000			
Poids	4,2 Kg / 1000		Résistance en traction	356 N/mm ²		

Observations :

Suivant Norme ISO 2768m

01/09/2019